

Light efficiency:



Light quality:



Color temperature:



Output: 3848 lm

Peak: 1762 cd

Power: 28,5 W

PF: 0,96

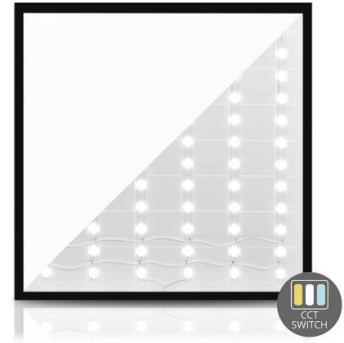

Tracking number: [VT241007-008181](#)

Product name:

277717-4000K

Item number:

277717-4000K

Date and time:

7-10-2024 15:57:22

Description:

BACK-LIT LED PANEEL | EUROPA | 60X60CM | 30W | ZWART | CCT-SWITCH

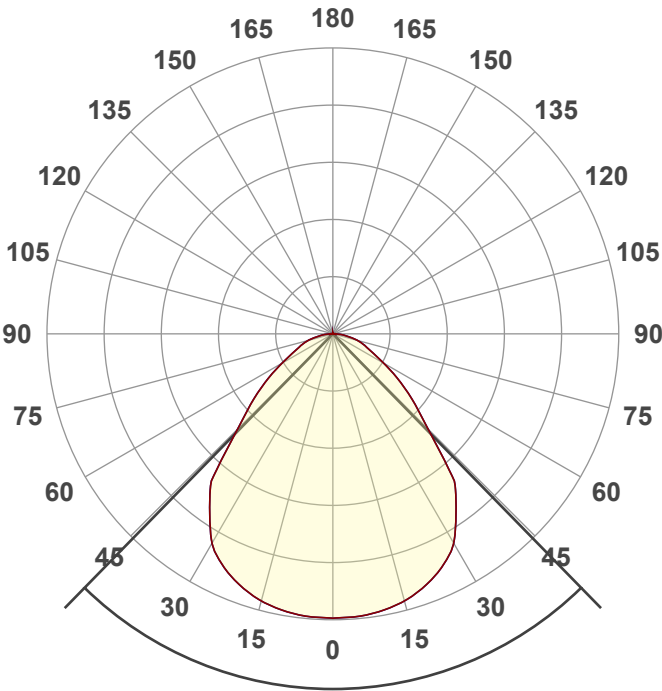

Beam angle **88,7°**



CIE 1931
x: 0,381
y: 0,377

Spectra

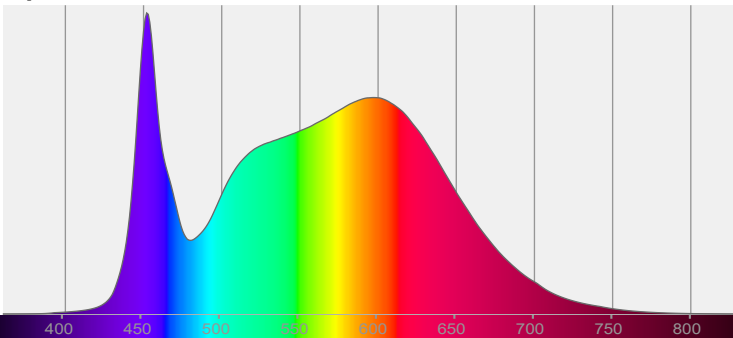

Power

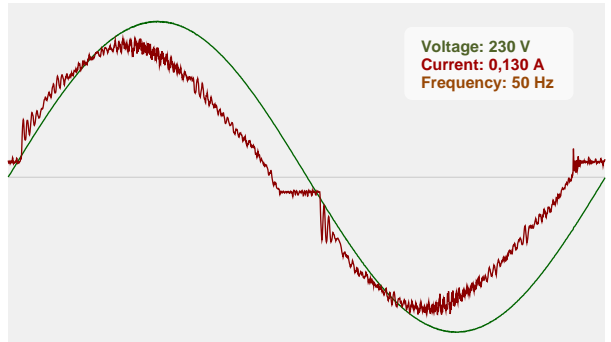

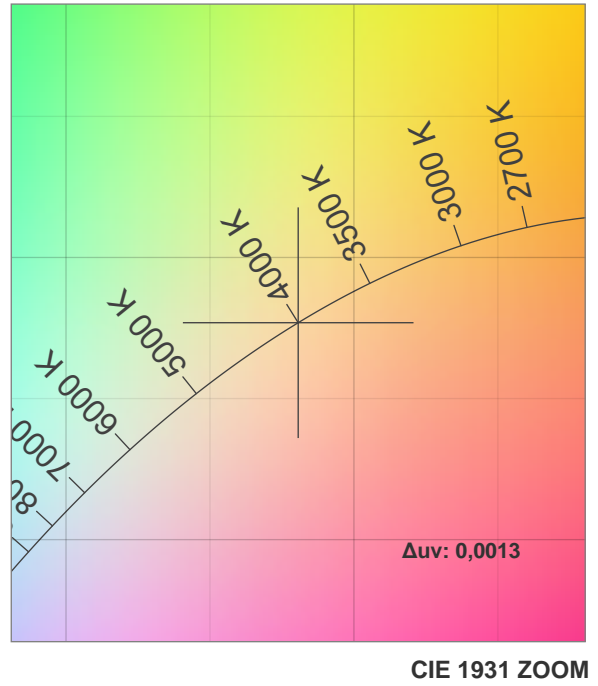
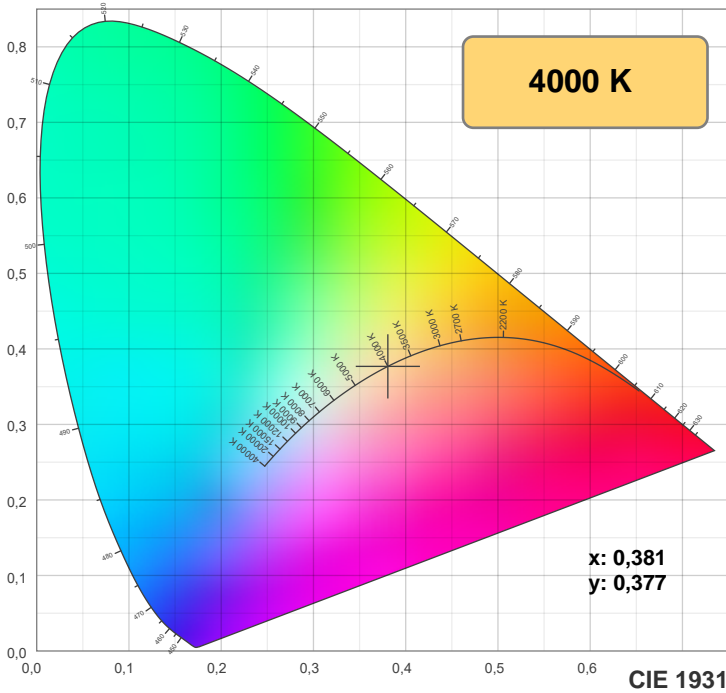

TM-30: 85,8

CRI: 86,6 (R1-R8)

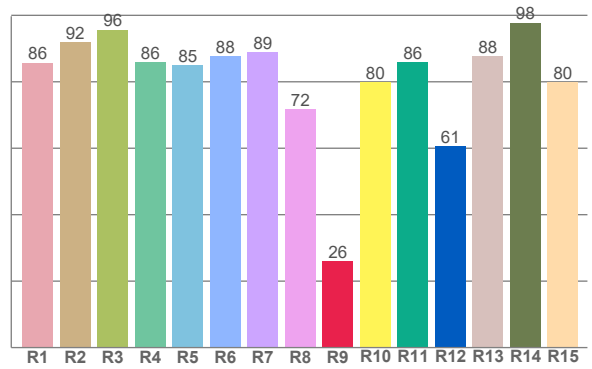
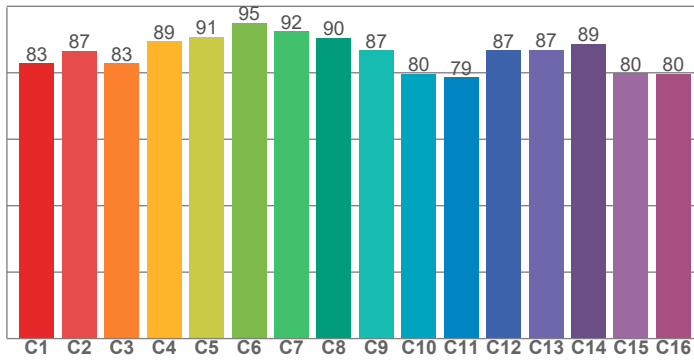

CRI R values, only R1-R8 are used to calculate final CRI value

| R1 | R2 | R3 | R4 | R5 | R6 | R7 | R8 | R9 | R10 | R11 | R12 | R13 | R14 | R15 |
|------|------|------|------|------|------|------|------|------|------|------|------|------|------|------|
| 85,8 | 91,8 | 95,7 | 85,9 | 85,1 | 87,8 | 88,9 | 71,8 | 26,1 | 79,9 | 85,9 | 60,6 | 87,6 | 97,8 | 79,8 |

TM30 C values, 16 binned values out of total of 99 C values

| C1 | C2 | C3 | C4 | C5 | C6 | C7 | C8 | C9 | C10 | C11 | C12 | C13 | C14 | C15 | C16 |
|------|------|------|------|------|------|------|------|------|------|------|------|------|------|------|------|
| 82,9 | 86,6 | 82,9 | 89,5 | 90,8 | 95,0 | 92,4 | 90,5 | 86,7 | 79,7 | 78,6 | 86,8 | 87,0 | 88,7 | 79,9 | 79,7 |

CQS Q values

| Q1 | Q2 | Q3 | Q4 | Q5 | Q6 | Q7 | Q8 | Q9 | Q10 | Q11 | Q12 | Q13 | Q14 | Q15 |
|------|------|------|------|------|------|------|------|------|------|------|------|------|------|------|
| 83,8 | 98,0 | 81,1 | 78,1 | 83,3 | 85,9 | 88,5 | 91,1 | 98,1 | 91,4 | 88,9 | 87,9 | 87,4 | 77,4 | 80,0 |

CQS: 85,4

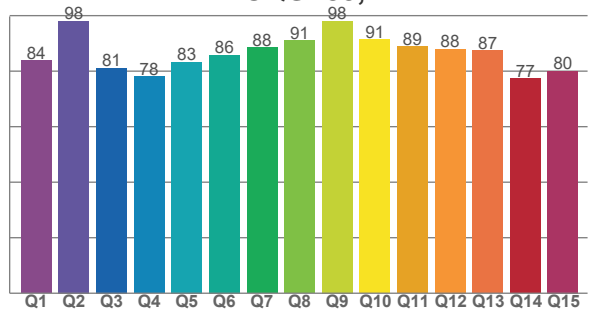

Color parameters

| Color temperature | Color rendering index | Red component | Color fidelity | Color gamut | Color quality scale | Color coordinate cie 1931 | Color coordinate cie 1931 | Color coordinate | Color coordinate | Color diviation from black body |
|-------------------|-----------------------|---------------|----------------|-------------|---------------------|---------------------------|---------------------------|------------------|------------------|---------------------------------|
| CCT | CRI | CRI R9 | TM30 Rf | TM30 Rg | CQS | x | y | u | v | Δuv |
| 4000 K | 86,6 | 26,1 | 85,8 | 95,8 | 85,4 | 0,381 | 0,377 | 0,225 | 0,334 | 0,0013 |

Rf 85,8
Fidelity index Rf

Rg 95,8
Gamut index Rg

| Hue Bin | R _f | Shifts (%) | |
|---------|----------------|------------|------|
| | | Chroma | Hue |
| 1 | 83 | -10% | 0% |
| 2 | 87 | -6% | 5% |
| 3 | 83 | -3% | 8% |
| 4 | 89 | -1% | 4% |
| 5 | 91 | -2% | 3% |
| 6 | 95 | 0% | -1% |
| 7 | 92 | -4% | -1% |
| 8 | 90 | -5% | 1% |
| 9 | 87 | -5% | 8% |
| 10 | 80 | -4% | 13% |
| 11 | 79 | 3% | 13% |
| 12 | 87 | 6% | 5% |
| 13 | 87 | 7% | -7% |
| 14 | 89 | 2% | -6% |
| 15 | 80 | -1% | -15% |
| 16 | 80 | -4% | -12% |

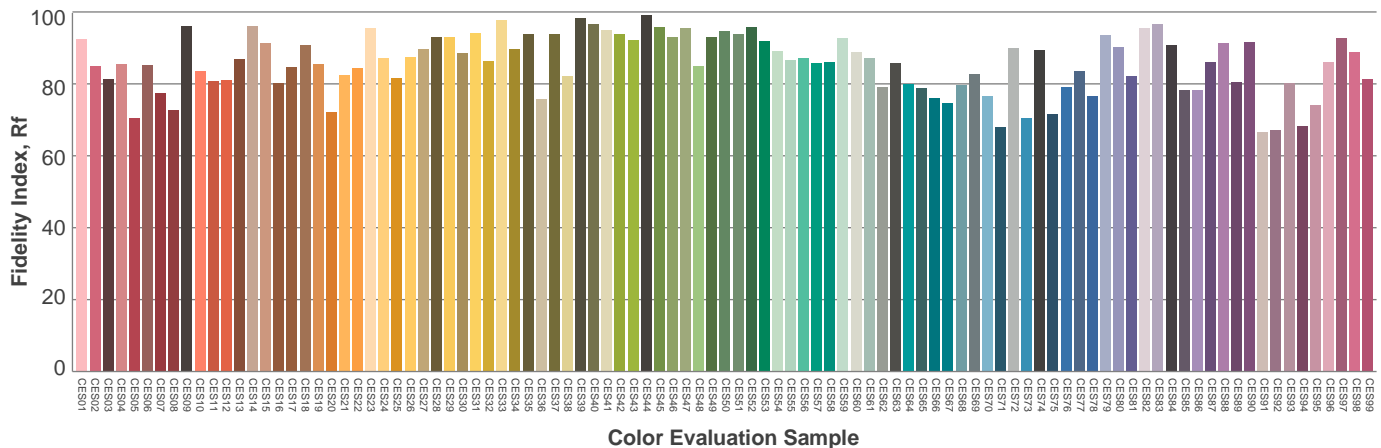
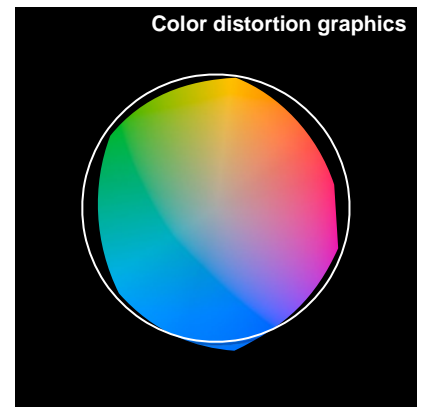
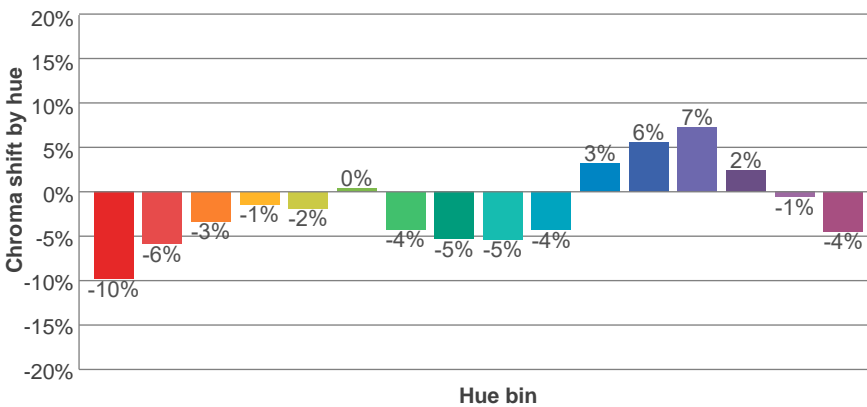
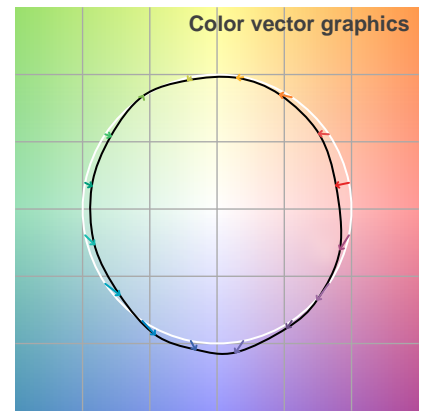
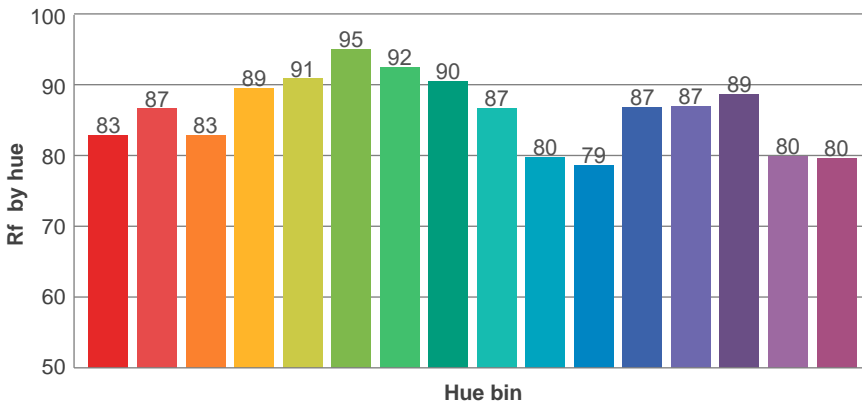
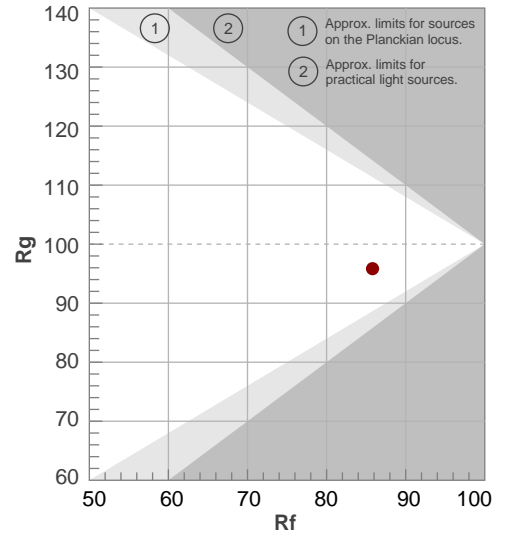

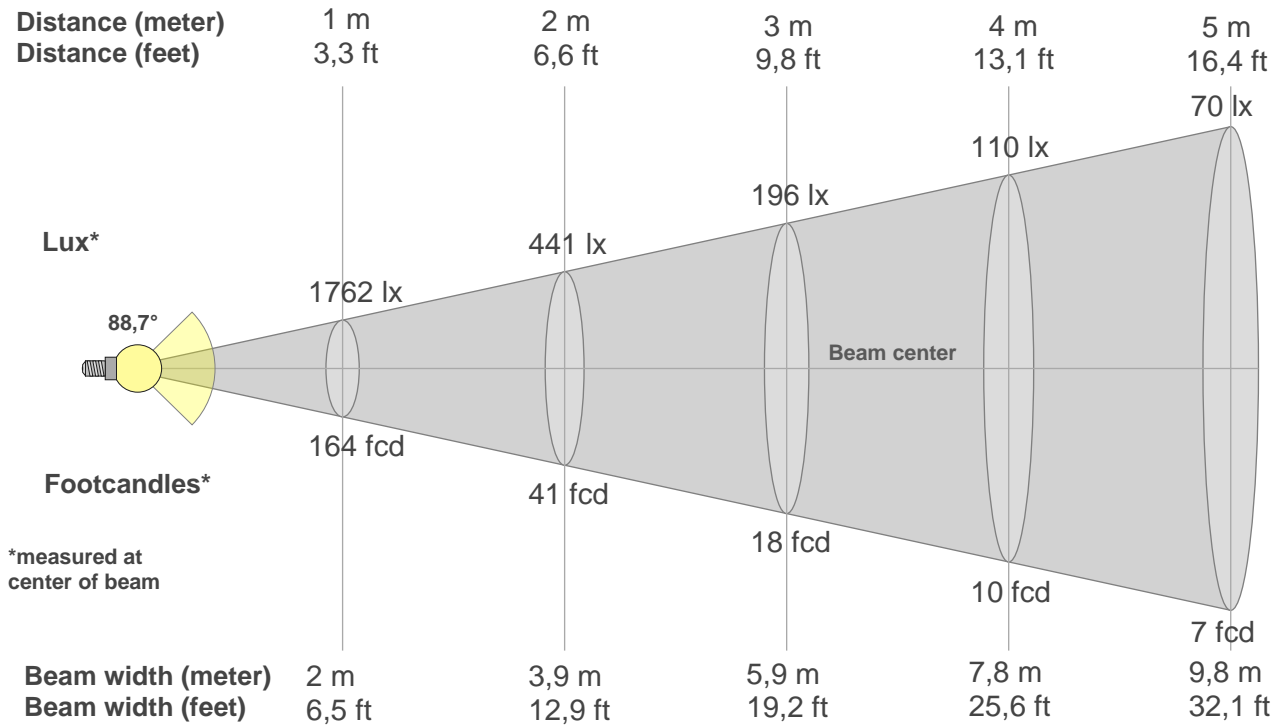

Beam intensities from 1-20m

| 1m | 2m | 3m | 4m | 5m | 6m | 7m | 8m | 9m | 10m | 11m | 12m | 13m | 14m | 15m | 16m | 17m | 18m | 19m | 20m |
|----------|---------|---------|---------|--------|--------|--------|--------|--------|--------|--------|--------|--------|--------|--------|--------|--------|--------|--------|--------|
| 3,3ft | 6,6ft | 9,8ft | 13,1ft | 16,4ft | 19,7ft | 23ft | 26,2ft | 29,5ft | 32,8ft | 36,1ft | 39,4ft | 42,7ft | 45,9ft | 49,2ft | 52,5ft | 55,8ft | 59,1ft | 62,3ft | 65,6ft |
| 1762lx | 441lx | 196lx | 110lx | 70lx | 49lx | 36lx | 28lx | 22lx | 18lx | 15lx | 12lx | 10lx | 9lx | 8lx | 7lx | 6lx | 5lx | 5lx | 4lx |
| 163,7fcd | 40,9fcd | 18,2fcd | 10,2fcd | 6,5fcd | 4,5fcd | 3,3fcd | 2,6fcd | 2fcd | 1,6fcd | 1,4fcd | 1,1fcd | 1fcd | 0,8fcd | 0,7fcd | 0,6fcd | 0,6fcd | 0,5fcd | 0,5fcd | 0,4fcd |

Intensities in 0° c-plane

| 0° | 5° | 10° | 15° | 20° | 25° | 30° | 35° | 40° | 45° | 50° | 55° | 60° | 65° | 70° | 75° | 80° | 85° | 90° | 95° |
|------|------|------|------|------|------|------|------|------|-----|-----|-----|-----|-----|-----|-----|-----|-----|-----|-----|
| 1762 | 1759 | 1743 | 1714 | 1664 | 1596 | 1494 | 1335 | 1136 | 843 | 653 | 499 | 366 | 279 | 209 | 159 | 96 | 53 | 12 | 2 |
| 100% | 100% | 99% | 97% | 94% | 91% | 85% | 76% | 64% | 48% | 37% | 28% | 21% | 16% | 12% | 9% | 5% | 3% | 1% | 0% |

Intensities in 90° c-plane

| 0° | 5° | 10° | 15° | 20° | 25° | 30° | 35° | 40° | 45° | 50° | 55° | 60° | 65° | 70° | 75° | 80° | 85° | 90° | 95° |
|------|------|------|------|------|------|------|------|------|-----|-----|-----|-----|-----|-----|-----|-----|-----|-----|-----|
| 1762 | 1759 | 1743 | 1714 | 1664 | 1596 | 1494 | 1335 | 1136 | 843 | 653 | 499 | 366 | 279 | 209 | 159 | 96 | 53 | 12 | 2 |
| 100% | 100% | 99% | 97% | 94% | 91% | 85% | 76% | 64% | 48% | 37% | 28% | 21% | 16% | 12% | 9% | 5% | 3% | 1% | 0% |

Intensities in 180° c-plane

| 0° | 5° | 10° | 15° | 20° | 25° | 30° | 35° | 40° | 45° | 50° | 55° | 60° | 65° | 70° | 75° | 80° | 85° | 90° | 95° |
|------|------|------|------|------|------|------|------|------|-----|-----|-----|-----|-----|-----|-----|-----|-----|-----|-----|
| 1762 | 1759 | 1743 | 1714 | 1664 | 1596 | 1494 | 1335 | 1136 | 843 | 653 | 499 | 366 | 279 | 209 | 159 | 96 | 53 | 12 | 2 |
| 100% | 100% | 99% | 97% | 94% | 91% | 85% | 76% | 64% | 48% | 37% | 28% | 21% | 16% | 12% | 9% | 5% | 3% | 1% | 0% |

Intensities in 270° c-plane

| 0° | 5° | 10° | 15° | 20° | 25° | 30° | 35° | 40° | 45° | 50° | 55° | 60° | 65° | 70° | 75° | 80° | 85° | 90° | 95° |
|------|------|------|------|------|------|------|------|------|-----|-----|-----|-----|-----|-----|-----|-----|-----|-----|-----|
| 1762 | 1759 | 1743 | 1714 | 1664 | 1596 | 1494 | 1335 | 1136 | 843 | 653 | 499 | 366 | 279 | 209 | 159 | 96 | 53 | 12 | 2 |
| 100% | 100% | 99% | 97% | 94% | 91% | 85% | 76% | 64% | 48% | 37% | 28% | 21% | 16% | 12% | 9% | 5% | 3% | 1% | 0% |

| Beam angle 50% | Field angle 10% | Cutoff angle 2,5% | Intensity ratio in 120° cone | Intensity ratio in 90° cone |
|----------------|-----------------|-------------------|------------------------------|-----------------------------|
| 88,7° | 146,5° | 172,1° | 86,5% | 67,1% |

iso-candela diagram

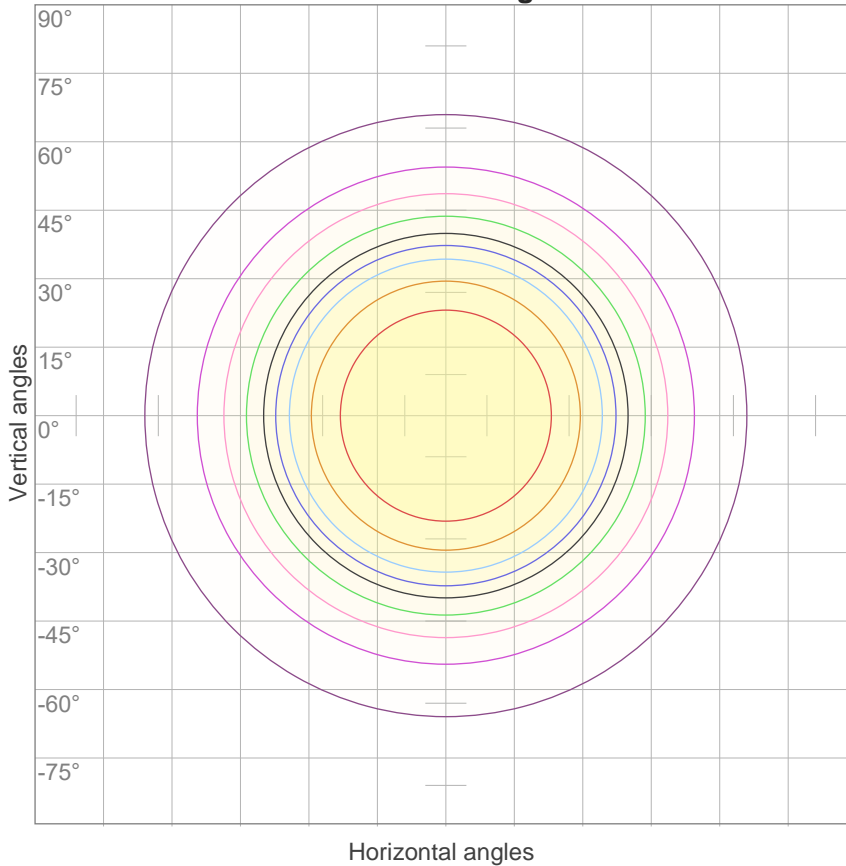

| | |
|-----|---------|
| 10% | 176 cd |
| 20% | 352 cd |
| 30% | 529 cd |
| 40% | 705 cd |
| 50% | 881 cd |
| 60% | 1057 cd |
| 70% | 1233 cd |
| 80% | 1410 cd |
| 90% | 1586 cd |

Conditions:

Number of c-planes: 12

Candela at center: 1762 cd

iso-lux diagram

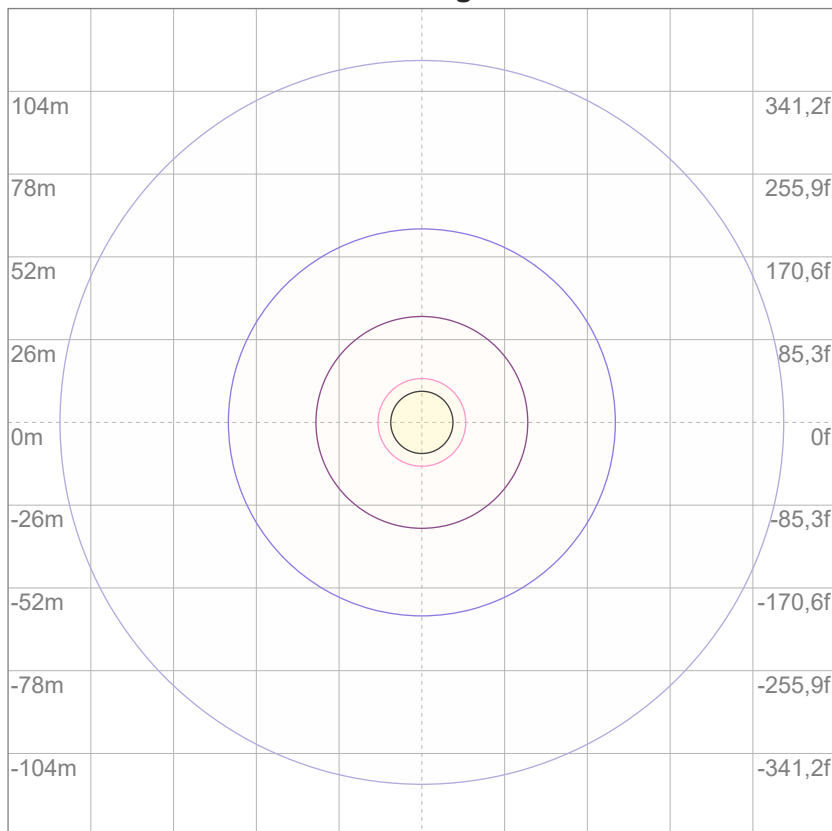

| | |
|-----|----------|
| 3% | 0,529 lx |
| 5% | 0,881 lx |
| 10% | 1,76 lx |
| 30% | 5,29 lx |
| 50% | 8,81 lx |

Conditions:

Number of c-planes: 12

Lux at center: 17,6 lx

Lux distribution on a surface when lamp is mounted at 10 meters from the surface.

Glare evaluation according to UGR

| | | | | | | | | | | | |
|--|-----|--|------|------|------|------|---|------|------|------|------|
| p Ceiling | | 70 | 70 | 50 | 50 | 30 | 70 | 70 | 50 | 50 | 30 |
| p Walls | | 50 | 30 | 50 | 30 | 30 | 50 | 30 | 50 | 30 | 30 |
| p Floor | | 20 | 20 | 20 | 20 | 20 | 20 | 20 | 20 | 20 | 20 |
| Room size X Y | | Viewing direction at right angles to lamp axis | | | | | Viewing direction parallel to lamp axis | | | | |
| 2H | 2H | 15,5 | 16,6 | 15,7 | 16,9 | 17,1 | 15,5 | 16,6 | 15,7 | 16,9 | 17,1 |
| | 3H | 16,3 | 17,5 | 16,7 | 17,7 | 17,9 | 16,3 | 17,5 | 16,7 | 17,7 | 17,9 |
| | 4H | 16,8 | 17,9 | 17,2 | 18,1 | 18,4 | 16,8 | 17,9 | 17,2 | 18,1 | 18,4 |
| | 6H | 17,2 | 18,1 | 17,5 | 18,4 | 18,8 | 17,2 | 18,1 | 17,5 | 18,4 | 18,8 |
| | 8H | 17,3 | 18,2 | 17,7 | 18,6 | 19,0 | 17,3 | 18,2 | 17,7 | 18,6 | 19,0 |
| | 12H | 17,4 | 18,3 | 17,8 | 18,6 | 19,1 | 17,4 | 18,3 | 17,8 | 18,6 | 19,1 |
| 4H | 2H | 15,8 | 16,9 | 16,2 | 17,1 | 17,4 | 15,8 | 16,9 | 16,2 | 17,1 | 17,4 |
| | 3H | 17,0 | 17,8 | 17,3 | 18,2 | 18,6 | 17,0 | 17,8 | 17,3 | 18,2 | 18,6 |
| | 4H | 17,5 | 18,3 | 17,9 | 18,7 | 19,3 | 17,5 | 18,3 | 17,9 | 18,7 | 19,3 |
| | 6H | 18,0 | 18,8 | 18,5 | 19,1 | 19,5 | 18,0 | 18,8 | 18,5 | 19,1 | 19,5 |
| | 8H | 18,2 | 18,9 | 18,7 | 19,3 | 19,6 | 18,2 | 18,9 | 18,7 | 19,3 | 19,6 |
| | 12H | 18,3 | 18,9 | 18,8 | 19,3 | 19,8 | 18,3 | 18,9 | 18,8 | 19,3 | 19,8 |
| 8H | 4H | 17,7 | 18,4 | 18,2 | 18,8 | 19,2 | 17,7 | 18,4 | 18,2 | 18,8 | 19,2 |
| | 6H | 18,4 | 18,9 | 18,9 | 19,4 | 19,9 | 18,4 | 18,9 | 18,9 | 19,4 | 19,9 |
| | 8H | 18,7 | 19,1 | 19,2 | 19,6 | 20,3 | 18,7 | 19,1 | 19,2 | 19,6 | 20,3 |
| | 12H | 18,9 | 19,3 | 19,5 | 19,8 | 20,4 | 18,9 | 19,3 | 19,5 | 19,8 | 20,4 |
| 12H | 4H | 17,7 | 18,3 | 18,2 | 18,7 | 19,2 | 17,7 | 18,3 | 18,2 | 18,7 | 19,2 |
| | 6H | 18,4 | 18,9 | 19,0 | 19,4 | 20,1 | 18,4 | 18,9 | 19,0 | 19,4 | 20,1 |
| | 8H | 18,7 | 19,1 | 19,3 | 19,6 | 20,3 | 18,7 | 19,1 | 19,3 | 19,6 | 20,3 |
| Variation of the observer position for the luminaire distance S | | | | | | | | | | | |
| S = 1.0H | | 0,2 / -0,3 | | | | | 0,2 / -0,3 | | | | |
| S = 1.5H | | 0,5 / -0,6 | | | | | 0,5 / -0,6 | | | | |
| S = 2.0H | | 1,1 / -0,9 | | | | | 1,1 / -0,9 | | | | |
| CIE 117-1995. Corrected glare indices referring to 3848 lm total luminous flux | | | | | | | | | | | |

Coefficients of Utilization

| Ceiling reflectance | 80 | | | | 70 | | | | 50 | | | 30 | | | 10 | | | 0 | | | |
|---------------------|---|-----|-----|-----|-----|-----|-----|-----|-----|-----|-----|-----|-----|-----|-----|-----|-----|----|----|----|---|
| Wall reflectance | 70 | 50 | 30 | 10 | 70 | 50 | 30 | 10 | 50 | 30 | 10 | 50 | 30 | 10 | 50 | 30 | 10 | 0 | | | |
| Floor reflectance | 20 | 20 | 20 | 20 | 20 | 20 | 20 | 20 | 20 | 20 | 20 | 20 | 20 | 20 | 20 | 20 | 20 | 20 | 20 | 20 | 0 |
| RCR | (RCR: Room Cavity Ratio) | | | | | | | | | | | | | | | | | | | | |
| | Room Values are expressed as percentage of Lumens delivered to the task surface | | | | | | | | | | | | | | | | | | | | |
| 0 | 119 | 119 | 119 | 119 | 116 | 116 | 116 | 116 | 111 | 111 | 111 | 106 | 106 | 106 | 102 | 102 | 102 | 99 | | | |
| 1 | 110 | 106 | 102 | 99 | 107 | 104 | 100 | 97 | 99 | 96 | 94 | 95 | 93 | 91 | 92 | 90 | 88 | 86 | | | |
| 2 | 101 | 94 | 88 | 83 | 99 | 92 | 87 | 82 | 89 | 84 | 80 | 85 | 82 | 78 | 82 | 79 | 76 | 74 | | | |
| 3 | 94 | 84 | 77 | 71 | 91 | 83 | 76 | 70 | 80 | 74 | 69 | 77 | 72 | 68 | 74 | 70 | 67 | 65 | | | |
| 4 | 86 | 76 | 68 | 62 | 84 | 74 | 67 | 61 | 72 | 65 | 60 | 70 | 64 | 60 | 67 | 63 | 59 | 57 | | | |
| 5 | 80 | 68 | 60 | 54 | 78 | 67 | 60 | 54 | 65 | 58 | 53 | 63 | 57 | 53 | 61 | 56 | 52 | 50 | | | |
| 6 | 74 | 62 | 54 | 48 | 73 | 61 | 54 | 48 | 60 | 53 | 47 | 58 | 52 | 47 | 56 | 51 | 47 | 45 | | | |
| 7 | 69 | 57 | 49 | 43 | 68 | 56 | 48 | 43 | 55 | 48 | 43 | 53 | 47 | 42 | 52 | 46 | 42 | 40 | | | |
| 8 | 65 | 52 | 44 | 39 | 63 | 52 | 44 | 39 | 50 | 43 | 39 | 49 | 43 | 38 | 48 | 42 | 38 | 36 | | | |
| 9 | 61 | 48 | 41 | 35 | 59 | 48 | 40 | 35 | 47 | 40 | 35 | 45 | 39 | 35 | 44 | 39 | 35 | 33 | | | |
| 10 | 57 | 45 | 37 | 32 | 56 | 44 | 37 | 32 | 43 | 37 | 32 | 42 | 36 | 32 | 41 | 36 | 32 | 30 | | | |

LAMPS (number of lamps)

Luminaire budgetary diagram

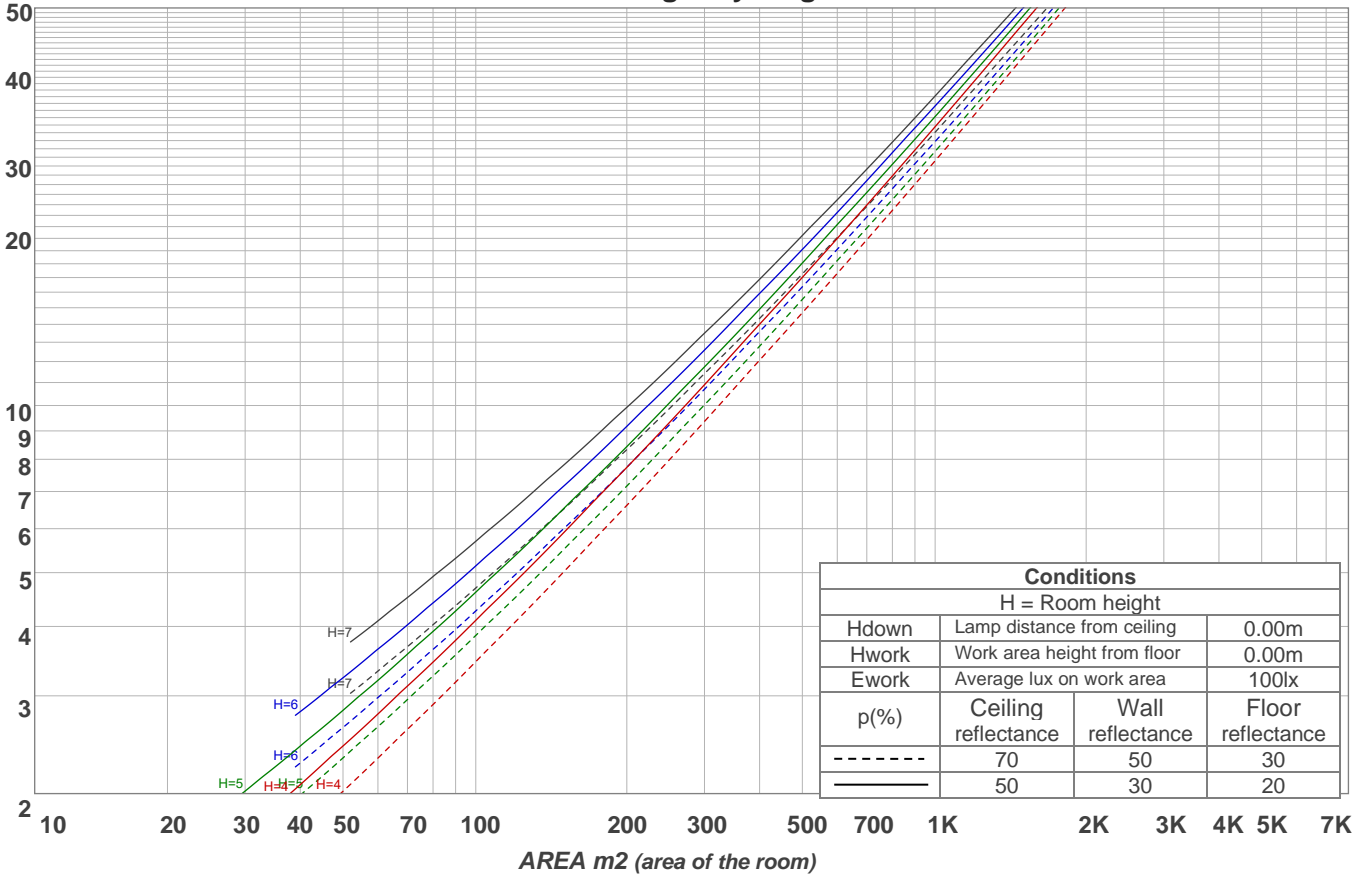

Zonal Lumen Summary

| | | | | | | | | |
|-----------|-----------|-----------|-----------|-----------|-----------|-----------|-----------|-----------|
| 0°-10° | 10°-20° | 20°-30° | 30°-40° | 40°-50° | 50°-60° | 60°-70° | 70°-80° | 80°-90° |
| {LUM0-10} | 483 lm | 733 lm | 832 lm | 665 lm | 449 lm | 276 lm | 165 lm | 57,5 lm |
| 90°-100° | 100°-110° | 110°-120° | 120°-130° | 130°-140° | 140°-150° | 150°-160° | 160°-170° | 170°-180° |
| 3,64 lm | 2,12 lm | 2,46 lm | 2,90 lm | 2,83 lm | 2,73 lm | 2,33 lm | 1,54 lm | 0,551 lm |

LCS table

| BUG rating: | B2 U2 G1 | |
|----------------------|----------|----------|
| Forward light | Lumens | Lumens % |
| Low(0-30): | 691,2 | 18% |
| Medium(30-60): | 972,6 | 25,3% |
| High(60-80): | 220,6 | 5,7% |
| Very high(80-90): | 28,8 | 0,7% |
| Back light | | |
| Low(0-30): | 691,2 | 18% |
| Medium(30-60): | 972,6 | 25,3% |
| High(60-80): | 220,6 | 5,7% |
| Very high(80-90): | 28,8 | 0,7% |
| Uplight | | |
| Low(90-100): | 3,9 | 0,1% |
| High(100-180): | 17,4 | 0,5% |

LCS graph

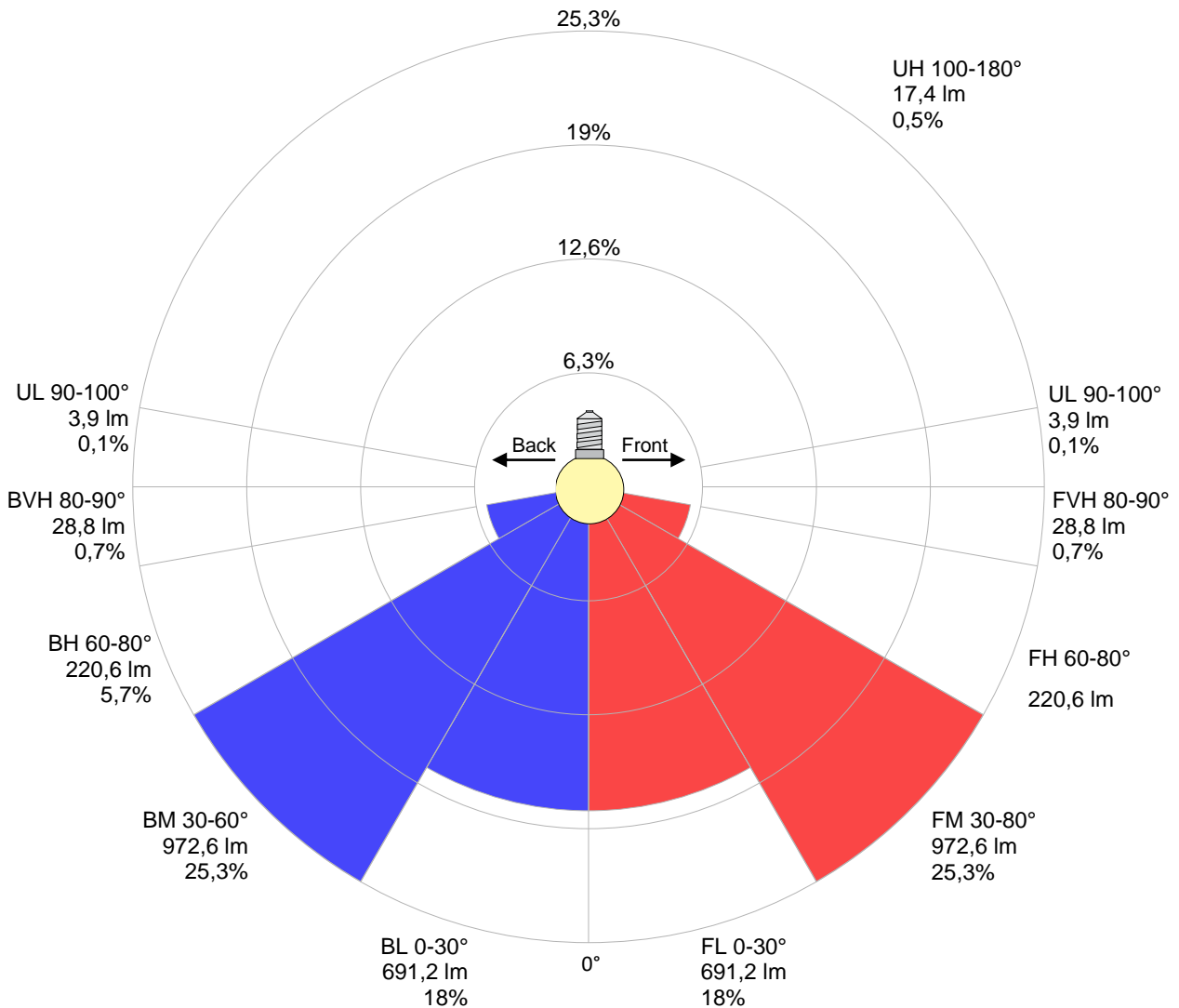

Warmup curve

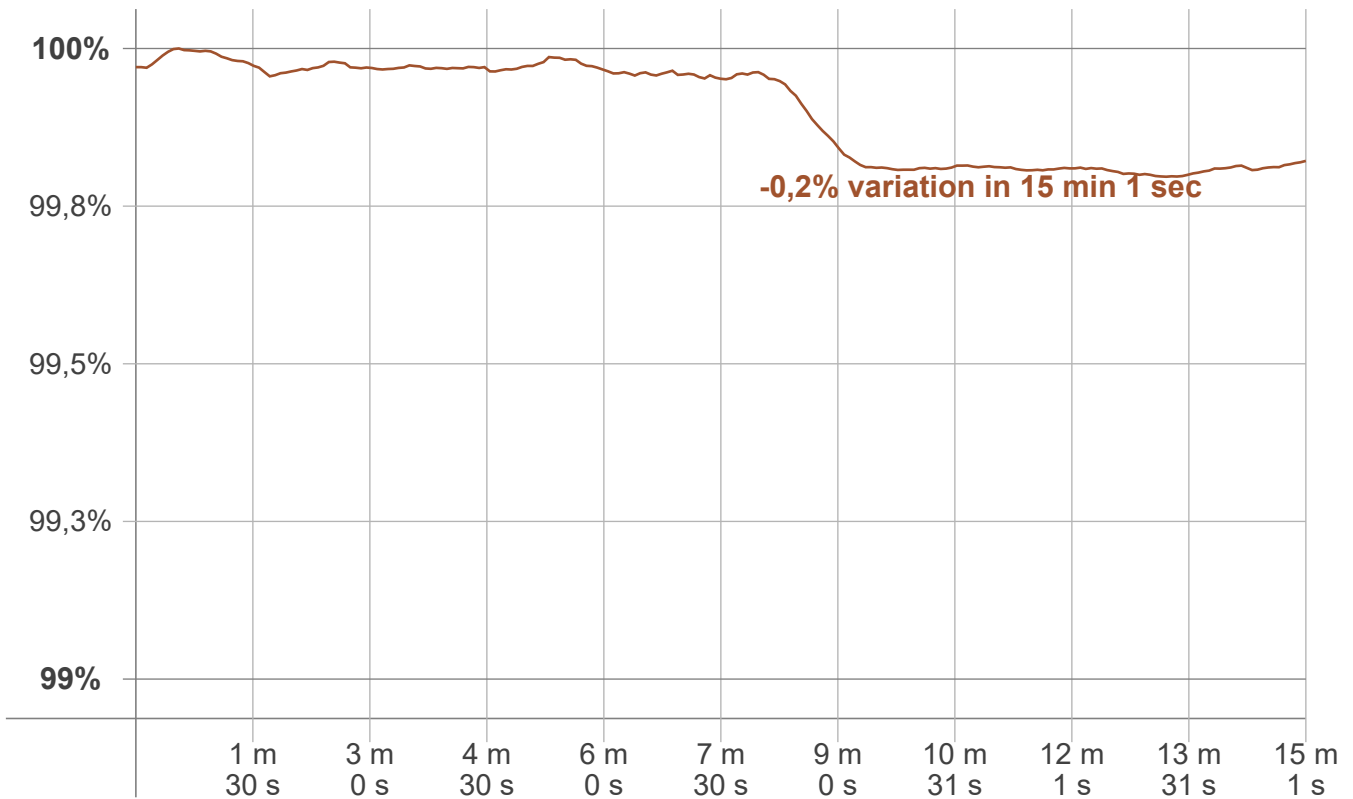

Warmup result

| | |
|-------------------------|--|
| Warmup time: | Lamp stabilized in 15 min 1 sec |
| Warmup variation | -0,2% |

Warmup conditions

| | |
|---------------------------|---------------|
| Stable period: | 15 min |
| Stable change max: | 2,0% |
| Minimum time: | 15 min |

Color temperature change

| CCT start | CCT change | CCT end |
|------------------|-------------------|----------------|
| 4048 K | -48 K | 4000 K |

Output change

| Output start | Output change | Output end |
|---------------------|----------------------|-------------------|
| 3854 lm | -6 lm | 3848 lm |

Flicker curve (complete sampled flicker signal)



Flicker frame (frame of one flicker period)

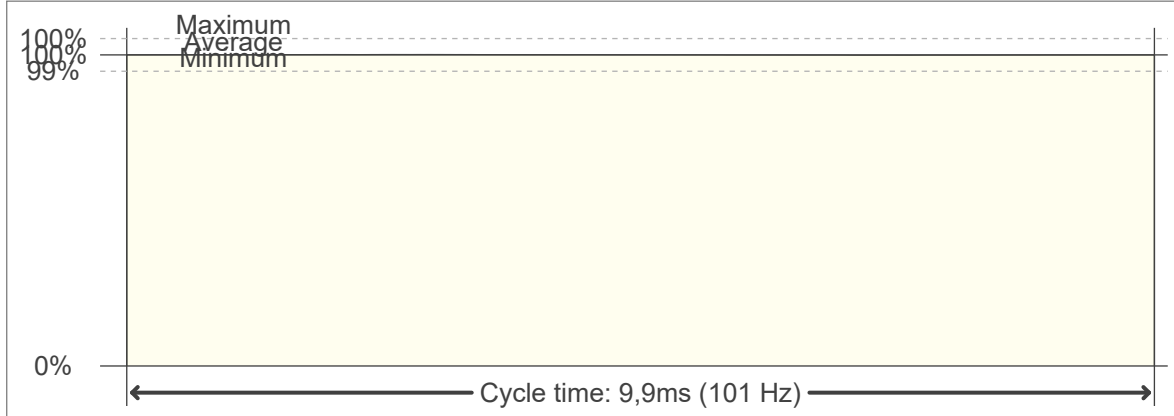

Flicker FFT (frequency scope of flicker curve)



Flicker results:

| Flicker frequency: | | 101,01 Hz | |
|-----------------------|--------|---------------|--------|
| Flicker index: | 0 | JA8/10 40Hz | 0,01 % |
| Flicker percentage: | 0,12 % | JA8/10 90Hz | 0,02 % |
| SVM: (Visual flicker) | 0 | JA8/10 200Hz | 0,1 % |
| PstLM | 0,01 | JA8/10 400Hz | 0,11 % |
| Mp | 0,01 | JA8/10 1000Hz | 0,11 % |

Flicker conditions:

| | |
|--------------|----------------------|
| Sample rate: | 20000 samples/second |
|--------------|----------------------|