

809034

Installation manual:

size

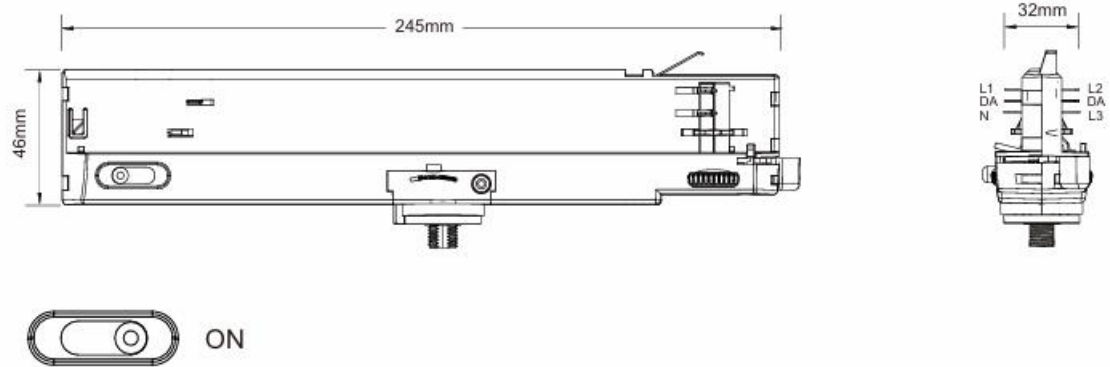

Mounting instruction

Max. allowed weight of complete luminaire: 5 kg (50 N).

It is valid for horizontal mounting of track system only. The mechanical key (A) is structure of providing fixed support.

The mechanical key (B) is anti-plug design.

To open rotate the lever the opposite direction.

Insert the adapter into the track



Do not stare at the light source

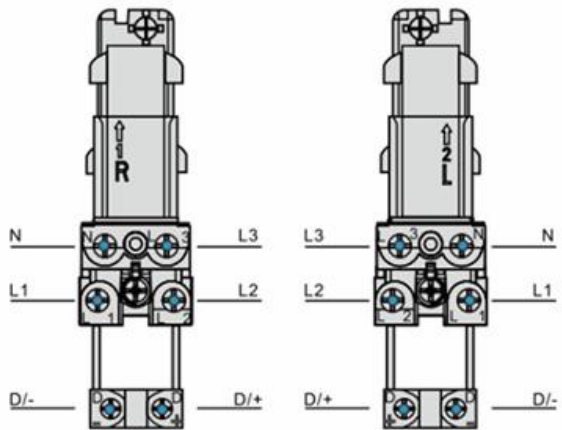
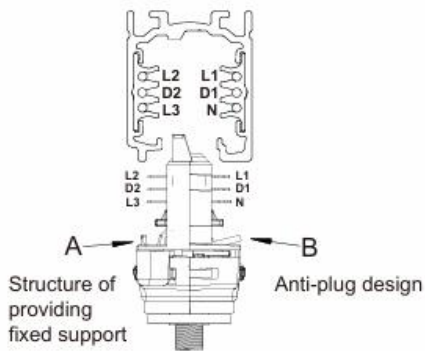

Mounting luminaire

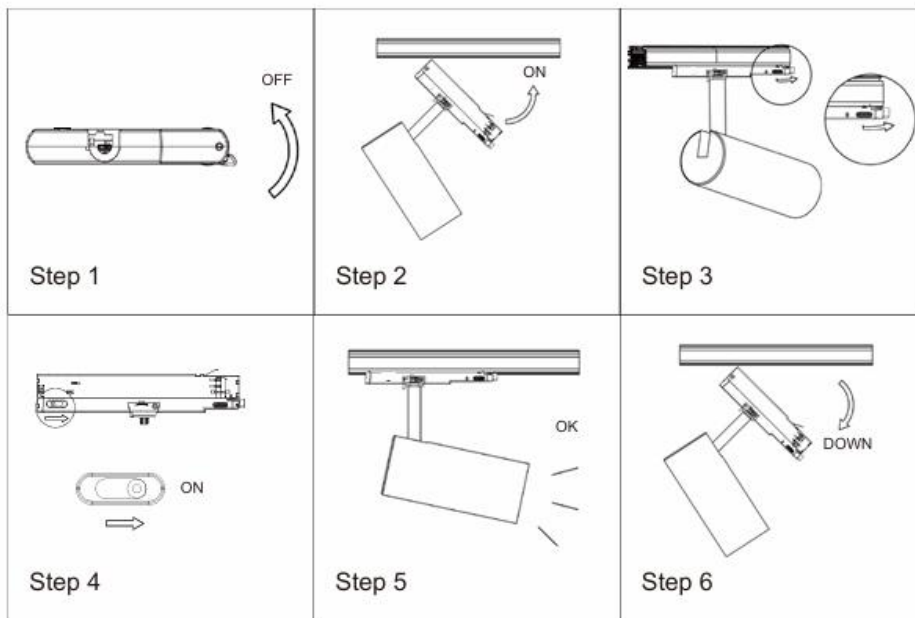

Caution: danger of electric shock

The luminaire should be installed and connected only by a qualified electrician.



Don't touch the LED!

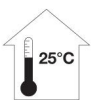

Recommended room temperature: 25 °C.